

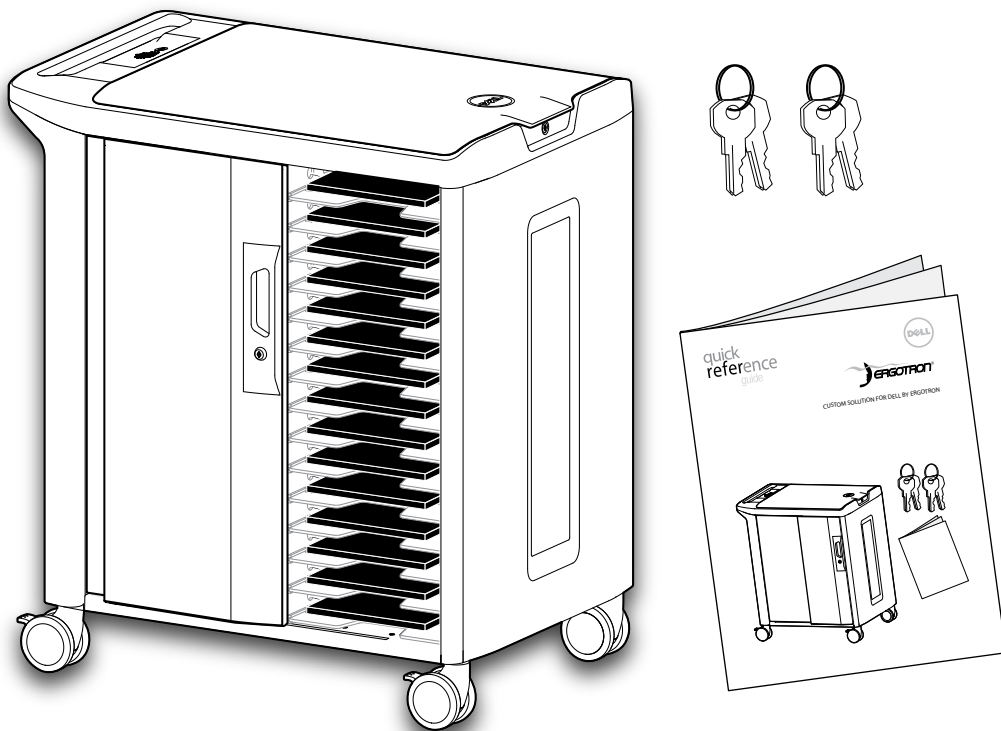

Custom Solution for Dell™ by Ergotron



Dell Mobile Computing Cart

Dell Mobile Computing Cart – Managed (with Docking) for Dell Latitude 3340

Models:
ERGITD-001
ERGITD-002



OJYR2 A01

For service, visit www.ergotron.com/Dell
or www.dell.com/support

Dell Mobile Computing Cart

Exterior Features

- 1 Sliding Device Compartment Door
- 2 Power Adapter Compartment Door
- 3 Ergonomic Handle
- 4 Auxiliary Outlets
- 5 Cooling Fans (Managed Carts only)
- 6 Power Management Compartment
- 7 Cord Wrap Bay

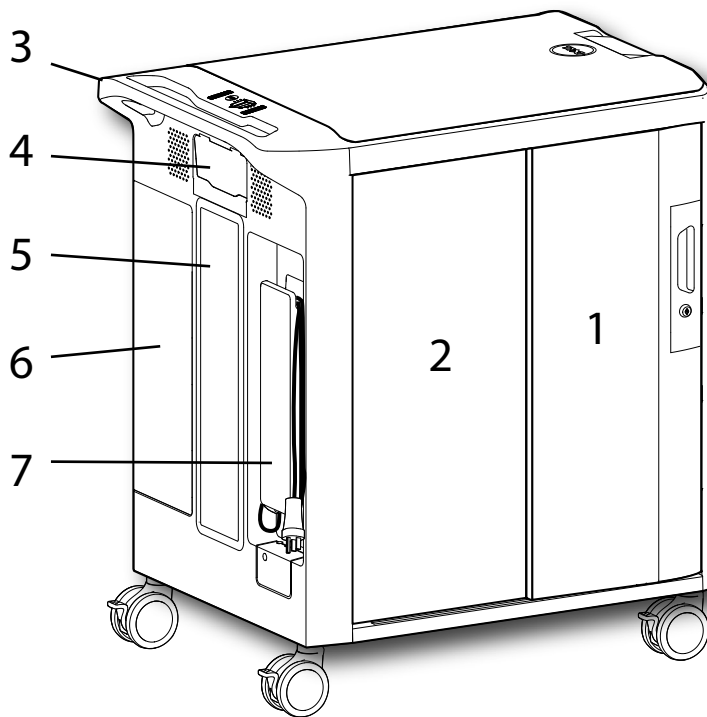

- 8 Upper Compartment
- 9 Locks
- 10 Power/ Fault Status Indicators (Managed Carts only)
- 11 Casters

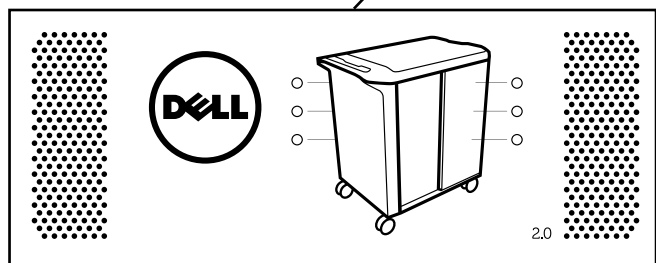
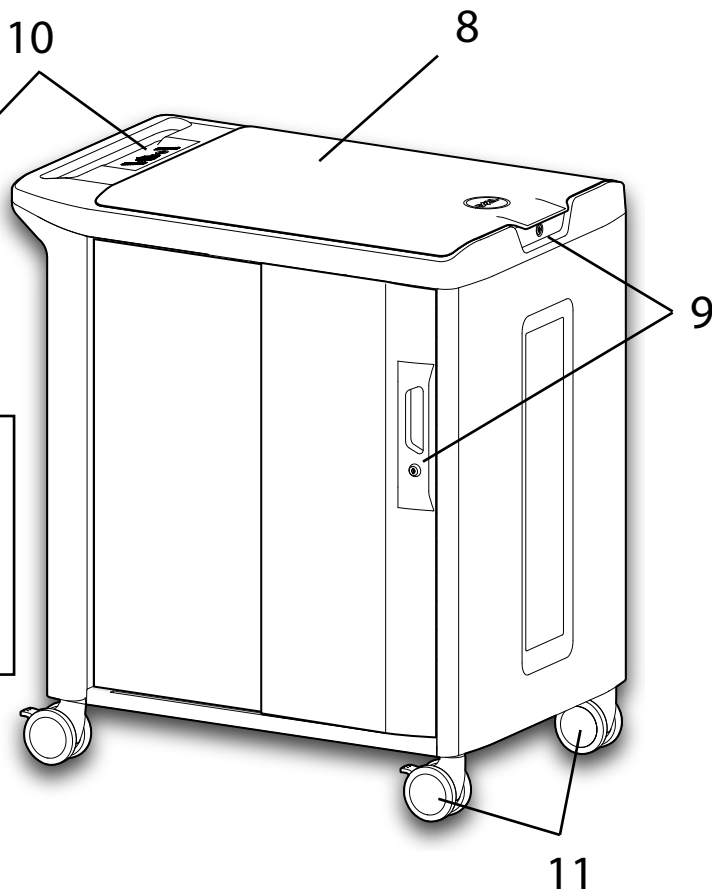

Dell Mobile Computing Cart

Interior Features

- 1 Device Shelves
- 2 Device Outlets
- 3 Adapter Shelves
- 4 Optional Outlets (Managed Carts only)
- 5 Optional Dell PowerConnect 3548 Ethernet Switch (Managed Carts only)

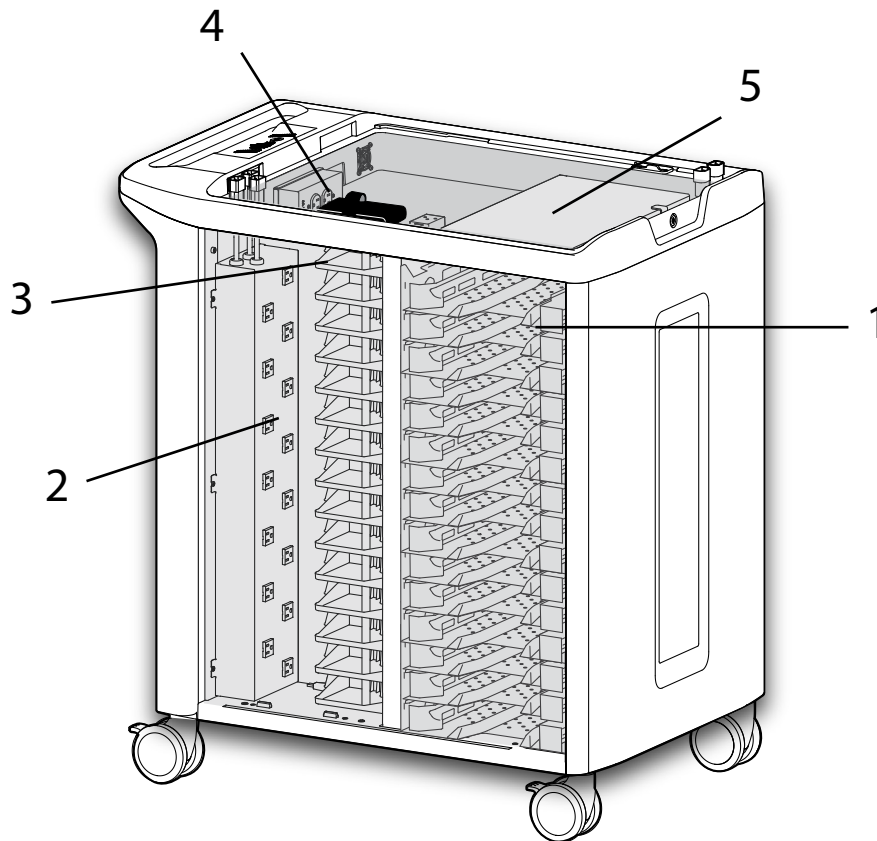

 NOTE: Refer to separate product guides for Mobile Devices and optional Dell PowerConnect™ 3548 Ethernet Switch.

Set-Up and Go

1 Open the power adapter compartment.

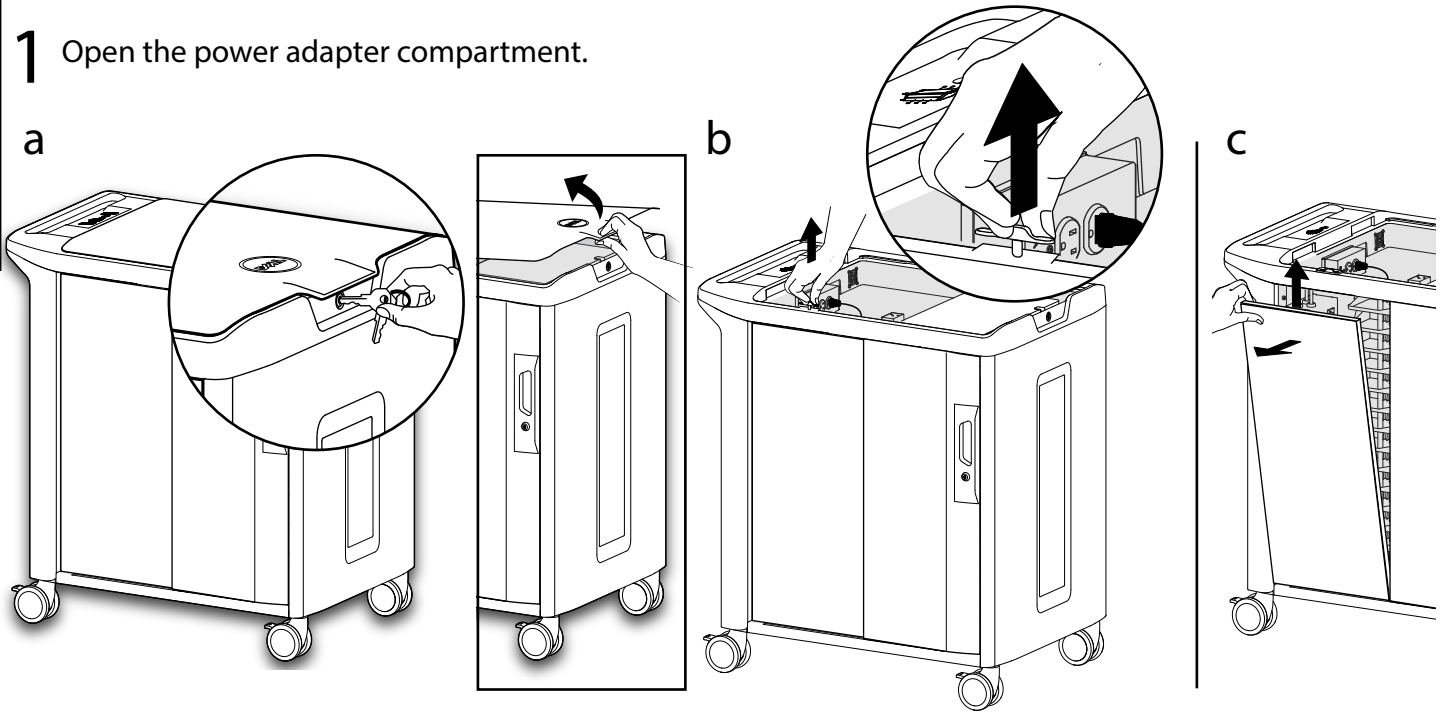

2 Place power adapters into adapter shelves.

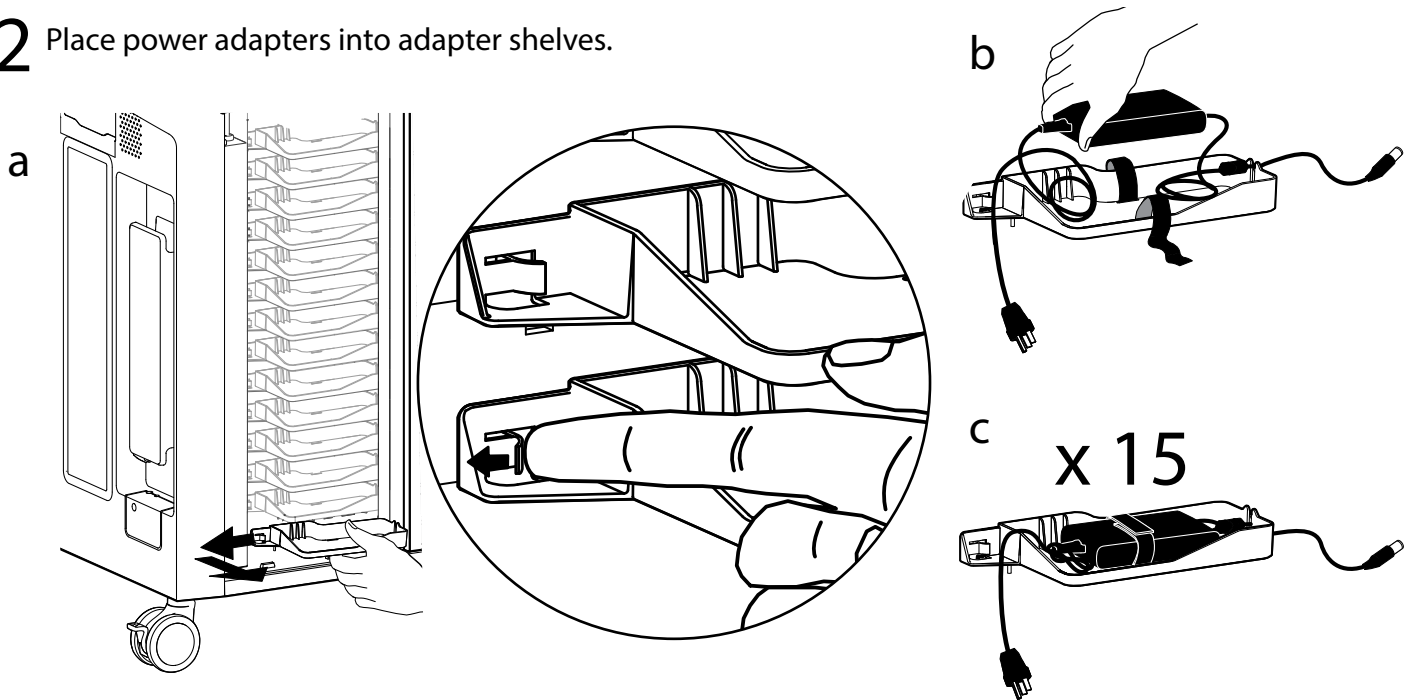

3 Plug-in adapters.

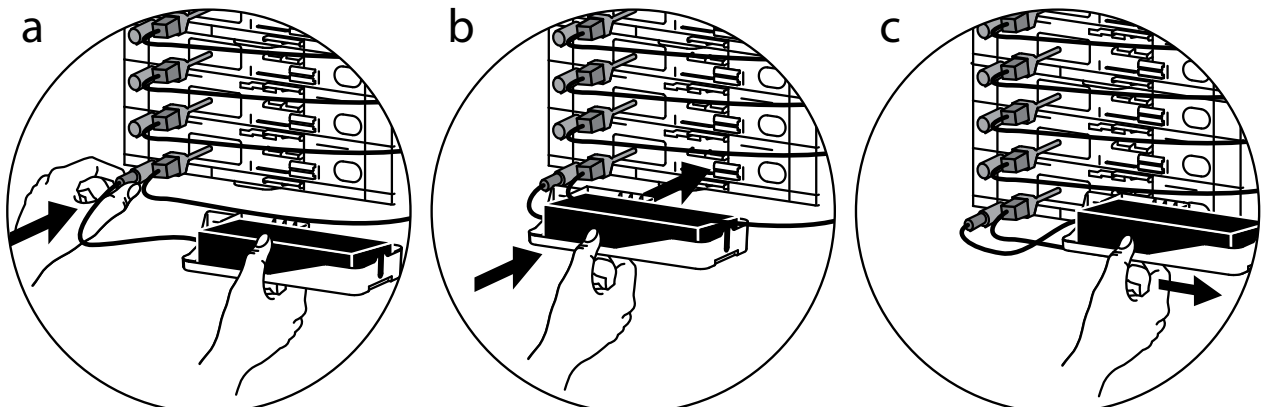

4 Plug-in adapters.

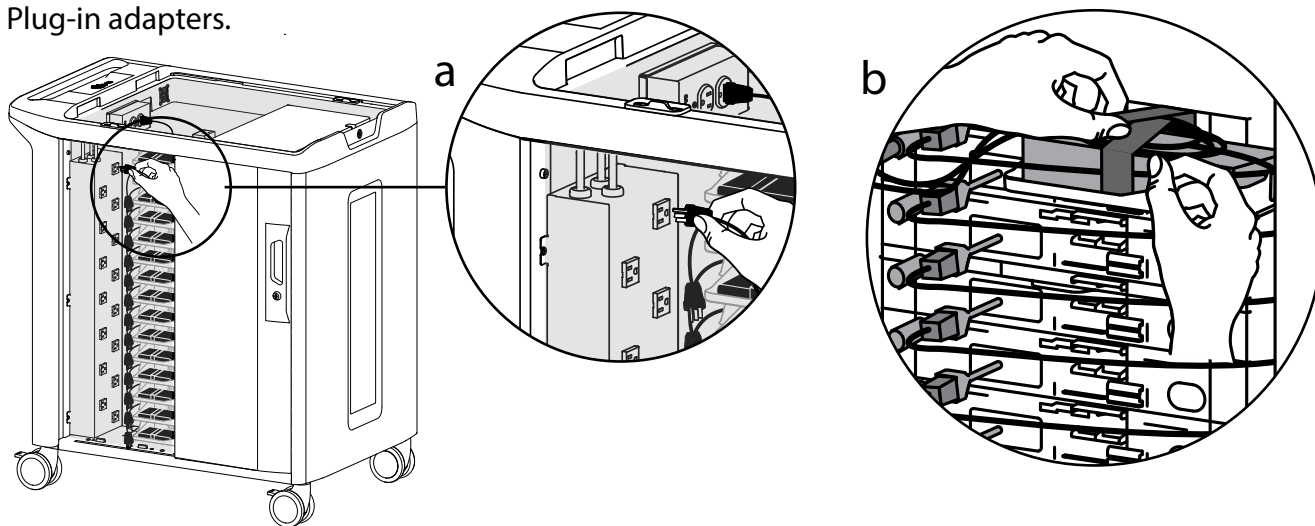

5 Insert mobile devices and connect cables.

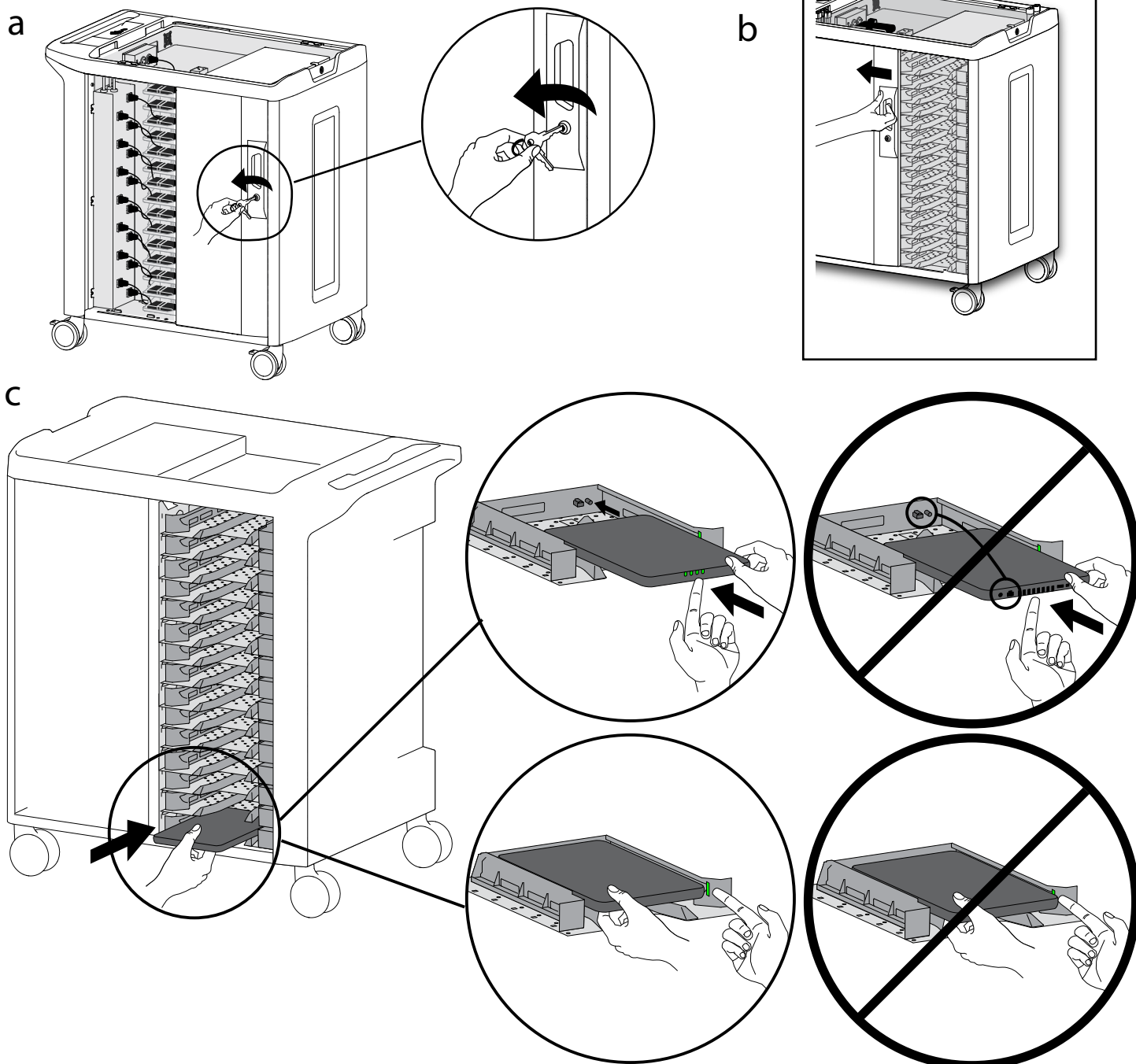

6 Optional Step for Managed Carts only - Install wireless access point.



NOTE: For Managed Carts, install optional, customer-supplied WAP using the provided Velcro.

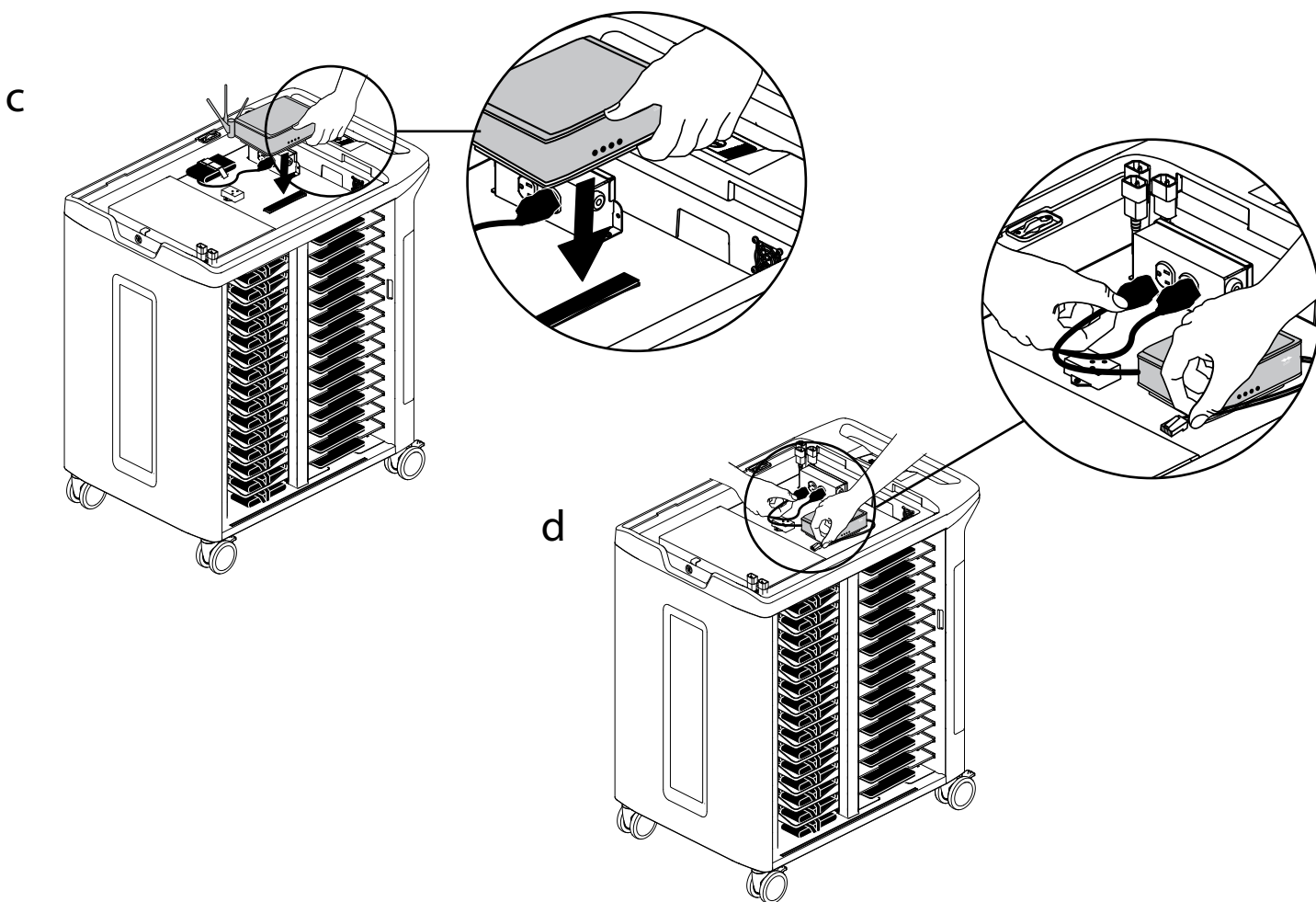
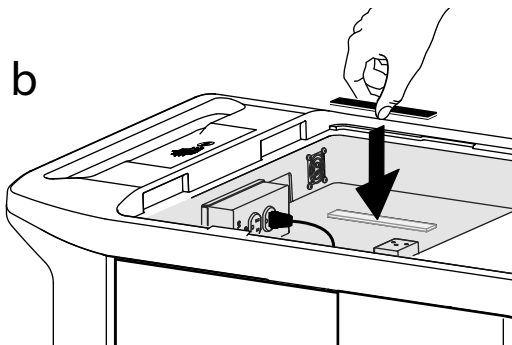
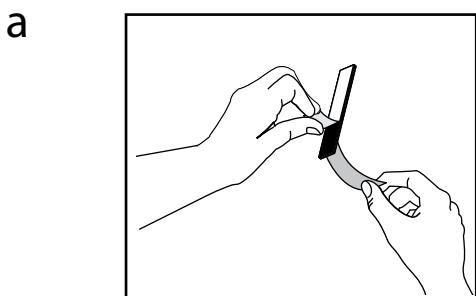

7 Verify cart operation

Connect the MCC power cable to a dedicated circuit, (one that is not being shared with other mobile devices).

Verify that the white light on the Power Indicator near the MCC top surface is lit (Managed Carts only).

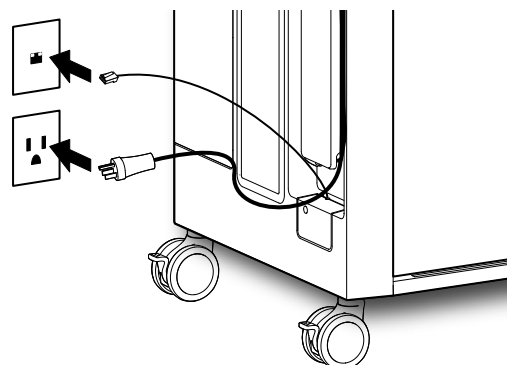

First-Time battery charge

 **NOTE:** Before using the mobile devices for the first time or after they have spent some time in storage, ensure that the mobile devices have a full (100%) charge.







Prior to first-time use, allow the mobile devices to charge in the MCC for at least 2-3 hours before removing them for use.

Monitoring mobile device power (Managed Carts only)

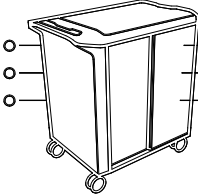
The Power/Fault Status Indicator lights near the MCC top surface communicate the following conditions:

Power/Fault Status Indicator Signal

Meaning

Zones			White light, solid	Power "ON"
			White light, slow flash	Zone is charging
			White light, fast flash	Zone is scanning
			All Fast Flashing	Overcurrent. Reset by removing excess devices on aux outlet. Unplug and re-plug the cart.
			Amber light, flashing	Maximum temperature has been exceeded *
			White light, solid	Auxiliary outlets in use

* When recommended temperature has been exceeded, power to the mobile devices is terminated. Charging resumes once the temperature falls within an acceptable operating range.

 **NOTE:** Charge status of individual mobile devices can be seen directly on mobile devices.

Notebook Shelf Removal

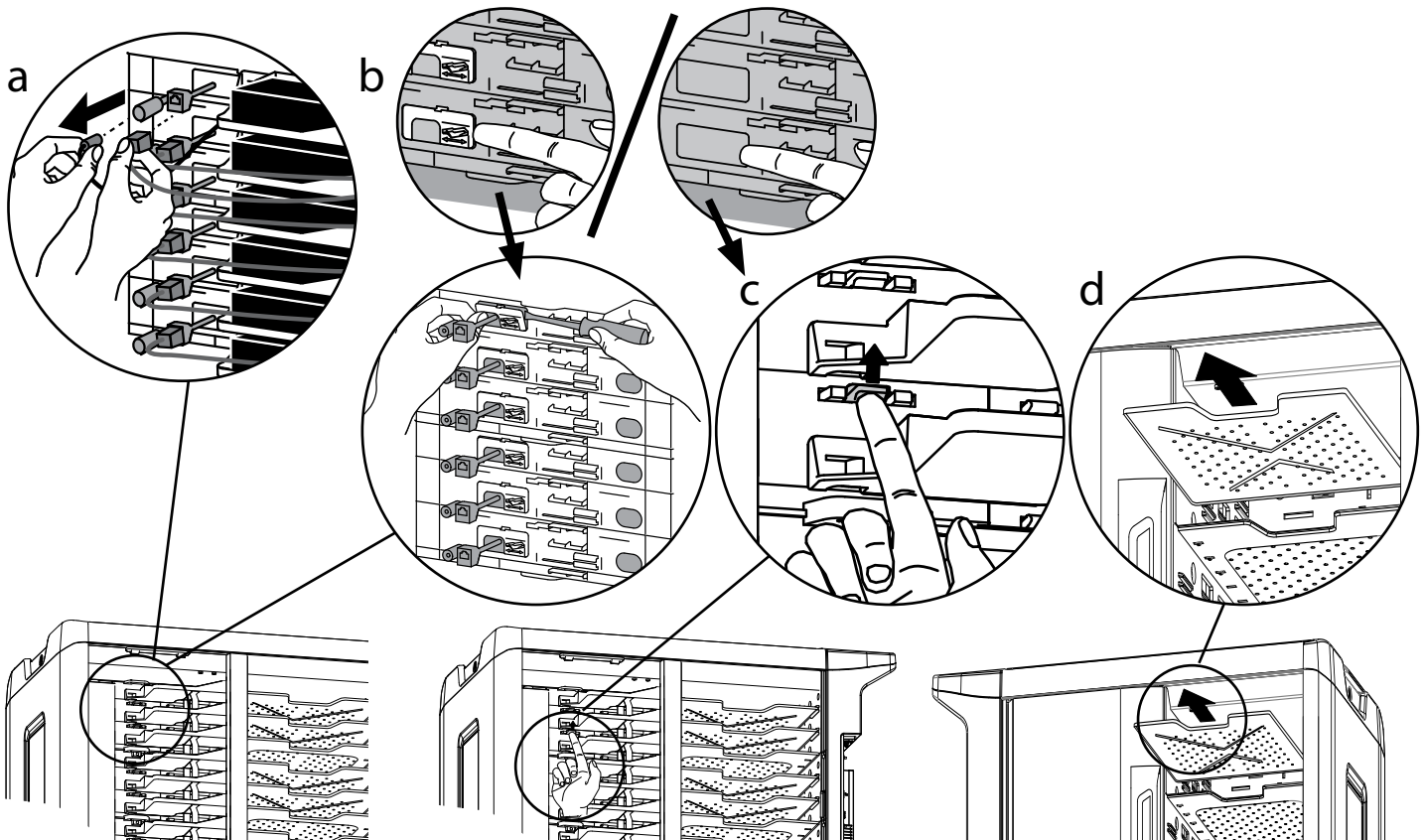

Service and Warranty

For service, visit www.ergotron.com/Dell
or www.dell.com/support



NOTE: When contacting customer service reference the serial number located above the external cable management bay.

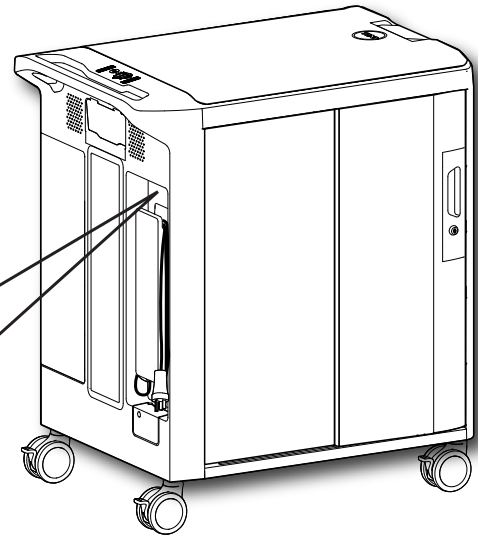

Serial Number is required for warranty entitlement.

Dell Mobile Computing Cart
Made in China DP/N 020D9K

CN-020D9K-14941-XXX-####
Service Tag: ABC1234

Rev A01

Specifications

Power System

100/110/120V~, 12A 50/60Hz or 220/230/240V~, 8A 50/60Hz
depending on region and model of Dell MCC

MCC Physical Dimensions

Height	1,060 mm (41.7-inches)
Length	940.6 mm (37-inches)
Width	640 mm (25.2-inches)
Weight (without Mobile Devices)	92 kg (202.8 lb)
Weight Capacity:	
Top Surface	11.3 kg (25 lb)
Shelves	2.7 kg (6 lb)
Tip Test/Angle	10 degrees

Optional Ethernet Switch

Dell PowerConnect 3548 Ethernet Switch

Environmental

Temperature range:

Operating	0° to 30°C (32° to 86°F)
Storage	-29° to 60°C (-20° to 140°F)

Relative humidity (maximum):

Operating	10%–90% (non condensing)
Storage	5%–95% (non condensing)

Altitude (maximum): 2000 m (6,562 ft)

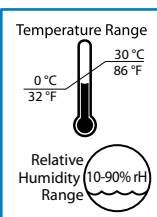

Operating

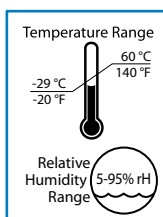





Storage

Product and Safety Alerts

Hazard Symbols Review

These symbols alert users of a safety condition that demands attention. All MCC users should be able to recognize and understand the significance of the following Safety Hazards if encountered on the MCC or within MCC documentation. Children who are not able to recognize and respond appropriately to Safety Alerts should not use the MCC without adult supervision!

Symbol	Signal Word	Level of Hazard
	NOTE	A NOTE indicates important information that helps you make better use of your MCC.
	CAUTION	A CAUTION indicates either potential damage to hardware or loss of data and tells you how to avoid the problem.
	WARNING	A WARNING indicates either potential for property damage, personal injury, or death.
	ELECTRICAL	An ELECTRICAL indicates an impending electrical hazard which, if not avoided, may result in personal injury, fire and/or death.

Equipment Electrical Safety

There are specific risks associated with the use of equipment having power cables. You must be aware of, and avoid these risks when the Cart is located in close proximity to children.

 **WARNING:** Failure to observe the following Electrical Safety notices can result in fire or death by electric shock.

 **Electrical:** Electrical cables can be hazardous. Misuse can result in fire or death by electrical shock.

- Double Pole / Neutral Fusing
- Inspect power cables thoroughly before each use.
- Do not use cables that are damaged.
- Insert the plug completely into the outlet.
- Grasp the plug to remove from the outlet.
- Do not unplug by pulling on the cable.
- Do not use excessive force to make connections.
- Use only Dell power adapters that come with Dell systems with this cart.
- Do not plug the cable into an extension cable.
- Do not remove, bend or modify any metal prongs or pins of cable.
- Do not drive, drag or place objects over the cable.
- Do not walk on the cable.
- Avoid overheating. Uncoil the cable and do not cover it with any material.
- Do not run cable through doorways, holes in ceilings, walls or floors.

 **Electrical:** Keep the Cart away from water.

- Do not use it when wet.
- Do not place the Cart in close proximity to flammable liquids or gases.

 **CAUTION:** Observe all the safety precautions related to the Dell MCC operation and maintenance included in this reference guide! Failure to follow the safety precautions may result in injury or damage to equipment.

 **CAUTION:** There is no on/off switch on this equipment; the only power disconnect is the AC power cable. Therefore, the socket outlet should be easily accessible and should be installed near the equipment.

 **DANGER!**
Risk of Electric Shock

DANGER! Electrical cables can be hazardous. Misuse can result in fire or death by electrical shock.





Cleaning and Maintenance

 **WARNING:** Failure to observe the following safety notices may result in serious personal injury or equipment damage.

Inspect for damage, dirt and debris on a regular basis. All paint and plastic components used in the Cart will withstand cleaning by most commonly used, diluted, non-abrasive solutions such as quaternary ammonia compounds, ammonia enzyme cleaners, bleach, or alcohol solutions. It is recommended that any cleaning solution be tested on a small, inconspicuous area to ensure it does not harm the surface of the Cart.

- Marks from permanent marker, dry-erase marker, and pens can be removed with 91% isopropyl alcohol and a soft cloth.
- Iodine stains can be removed with commonly used cleaners and a soft cloth.
- Do not use steel wool or other abrasive materials that may damage the surface finish.

 **Electrical:** To avoid risk of electric shock, do not expose electrical components to water, cleaning solutions or other potentially corrosive liquids or substances.

 **Electrical:** Do not immerse Cart or Cart components in liquid or allow liquids to flow into the Cart. Wipe all cleaners off surface immediately using a damp cloth. Dry the surface thoroughly after cleaning.

 **Electrical:** Do not use flammable cleaners on Cart surfaces.

 **CAUTION:** Adjustment, Service, Replacement - DO NOT attempt to adjust, service or replace any part of the Cart unless directed to do so through Ergotron-approved documentation (i.e. installation instructions). Only Ergotron, Inc. or an Ergotron-certified entity may adjust, service or replace Cart components. If any component on the Cart is missing or damaged, the Cart must not be used. Contact Ergotron immediately to request a replacement part.

 **CAUTION:** Casters - Check casters periodically to make sure they are clean and free of debris that would prevent smooth travel. Avoid moving Cart across uneven, dirty, or damaged surfaces.

 **CAUTION:** Customer Equipment- Make sure equipment is balanced and installed securely to Cart. Contact Ergotron for information about moving Cart components.

 **CAUTION:** Changes or Modifications not expressly approved by Ergotron could void the user's authority to operate the equipment.

Safe Use Recommendations

There are specific risks associated with the use of Cart when moving or stationary (for charging or storage). You must be aware of, and avoid these risks when the Cart is located in close proximity to children.

 **WARNING:** Failure to observe the following Cart Use Safety notices may result in serious personal injury or equipment damage.

Only Adults should move this cart.

- Do not allow anyone to sit, stand, or climb on the Cart.
- Do not lift the Cart from the bottom.
- Do not block the fans and vent openings. To prevent overheating, leave at least 127 mm (5-inch) clearance around fans and vents.

The Cart is designed to be used indoors only.

- Do not use the Cart to transport or store equipment other than what has been noted in this guide.
- Do not use the Cart to store liquids or cleaning supplies.
- Do not place heavy objects on the Cart surface or shelf.
 - The maximum weight capacity of the top surface is 11.4 kg (25 lb).
 - The maximum weight capacity of the shelf is 22.5 kg (49.5 lb).

Moving the Cart

- Before moving the Cart:
 1. Disconnect the power cable from the wall.
 2. Make sure the cable is wrapped and secure.
 3. Close and lock the doors.
 4. Remove items from the top work surface.
 5. Unlock the casters.
- Push (do not pull) the Cart for optimum maneuverability and to prevent muscle strain.
- Do not move the Cart across rough, uneven or irregular surfaces such as gravel.

Parking the Cart

Observe these safety alerts for times when the cart is stationary:

- Do not park the Cart in areas of heavy traffic.
- Do not run cables through doorways, holes in ceilings, walls, or floors.
- Do not run cables across hallways, classrooms, or other areas where they will be walked on.
- Do not leave Cart unattended in areas where children have access.
- Keep Cart doors closed and locked whenever it is unattended or parked for charging or storage.
- Keep Cart casters locked whenever it is unattended.

Safety, Environmental, and Regulatory Information



Recycling Information

Dell recommends that customers dispose of their used computer hardware, monitors, printers, and other peripherals in an environmentally sound manner. Potential methods include reuse of parts or whole products and recycling of products, components, and/or materials.

For specific information on Dell's worldwide recycling programs, see www.dell.com/recyclingworldwide.



In the European Union, this label indicates that this product should not be disposed of with household waste. It should be deposited at an appropriate facility to enable recovery and recycling. For information on how to recycle this product in your country, please visit: www.euro.dell.com/recycling.



В Европейския съюз този етикет означава, че този продукт не бива да се изхвърля заедно с домакинските отпадъци. Той трябва да бъде изхвърлен на подходящо място, за да се позволи възстановяването или рециклирането му. За информация относно отговорността за рециклиране на този продукт във вашата страна, моля посетете: www.euro.dell.com/recycling.



Tento štítek označuje v Evropské unii, že tento produkt nesmí být likvidován s domovním odpadem. Musí být předán specializované sběrně pro recyklaci a další využití. Pokyny o recyklaci tohoto produktu ve vaší zemi viz: www.euro.dell.com/recycling.



I den Europeiske Union indikerer denne etiket, at dette produkt ikke bør kasseres sammen med husholdningsaffald. Det bør bortskaffes ved en egnet facilitet for at muliggøre genbrug. For information om hvordan dette produkt genbruges i dit land, bedes du gå til: www.euro.dell.com/recycling.

Richtlijn WEEE, Waste Electrical and Electronic Equipment (afदानken van elektrische en elektronische apparaten)



In de Europese Unie geeft dit label aan dat dit product niet via huishoudelijk afval mag worden afgevoerd. Het moet gedeponeerd worden bij een daarvoor geschikt voorziening zodat herstel en recycling mogelijk zijn. Raadpleeg voor meer informatie over verantwoorde recycling van dit product in uw land de website www.euro.dell.com/recycling.

Elektriliste ja elektrooniliste seadmete kasutusjärgne töötlemine (direktiiv WEEE)



Europa Liidu riikides tähistab selline silt toodet, mida ei tohi kasutusjärgselt olmejäätmete hulka visata. Tavaline toode tuleb viia jäätmekäitlusettevõttesse, kus seda nõuetekohaselt töödeldakse. Toote käitlemise kohta oma kodumaal leiate teavet aadressilt www.euro.dell.com/recycling.

Direktiivi sähkö- ja elektroniikkalaiteromusta (WEEE)



European unionissa tämä tarkoittaa, että tuotetta ei tule hävittää kotitalousjätteen joukossa. Se tulee toimittaa asianmukaiseen paikkaan uudelleenkäyttöä tai kierrätystä varten. Tietoja tämän tuotteen kierrättämisestä eri maissa saat seuraavasta osoitteesta: www.euro.dell.com/recycling.

Directive sur la mise au rebut des appareils électriques et électroniques (Waste Electrical and Electronic Equipment - WEEE)



En Union européenne, cette étiquette indique que ce produit ne doit pas être jeté avec les déchets ménagers. Il doit être mis au rebut dans un centre de dépôt spécialisé pour un recyclage approprié. Pour obtenir davantage d'informations sur le recyclage approprié de ce produit dans votre pays, veuillez vous rendre sur le site : www.euro.dell.com/recycling.

Richtlinie für Abfall von elektrischen und elektronischen Geräten (WEEE)



In der Europäischen Union wird mit diesem Etikett darauf hingewiesen, dass dieses Produkt nicht mit dem Hausmüll entsorgt werden sollte. Es sollte an einer entsprechenden Einrichtung abgegeben werden, um Wiedergewinnung und Recycling zu ermöglichen. Weitere Informationen über das Recyclein dieses Produkts erhalten Sie unter: www.euro.dell.com/recycling.

Οδηγία σχετικά με τα απόβλητα ειδών ηλεκτρικού και ηλεκτρονικού εξοπλισμού (AHHE)



Στην Ευρωπαϊκή Ένωση, αυτή η ετικέτα υποδεικνύει ότι αυτό το προϊόν δεν πρέπει να απορριπτεί μαζί με τα οικιακά απορρίμματα. Θα πρέπει να αποκοιμίζεται σε κατάλληλο χώρο ώστε να είναι δυνατή η ανάκτηση και η ανακύκλωση. Για πληροφορίες σχετικά με την ανακύκλωση αυτού του προϊόντος στη χώρα σας, επισκεφθείτε τη διεύθυνση: www.euro.dell.com/recycling.

Waste Electrical and Electronic Equipment (WEEE), azaz az elektromos és elektronikus berendezések hulladékaira vonatkozó irányelv



Az Európai Unióban az ilyen címkével jelölt terméket tilos háztartási hulladékként kezelni. Az ilyen hulladékokat a helyreállítathóság és az újrahasznosíthatóság érdekében a megfelelő elfogadóhelyre kell szállítani. A termék saját országán belüli érvényes újrahasznosításával kapcsolatban információt a következő weboldalon talál: www.euro.dell.com/recycling.

Direttiva Rifiuti di apparecchiature elettriche ed elettroniche (RAEE)



Nell'Unione Europea, questa etichetta indica che questo prodotto non deve essere smaltito insieme ai rifiuti domestici. Deve essere depositato in una impianto adeguato che sia in grado di eseguire operazioni di recupero e riciclaggio. Per informazioni sulle procedure di riciclaggio di questo prodotto nel proprio Paese, visitate: www.euro.dell.com/recycling.

Direktiva par elektriskajiem un elektroniskajiem atkritumiem



Eiropas Savienībā šis apzīmējums norāda, ka produktu nedrīkst izvest kopā ar sadzīves atkritumiem. Tas ir jānodod atbilstošā savākšanas punktā, lai pareizi atjaunotu vai pārstrādātu. Informāciju par šī produkta pārstrādes iespējām jūsu valstī skatiet: www.euro.dell.com/recycling.

Direktiva dėl elektros ir elektroninės įrangos atliekų (Waste Electrical and Electronic Equipment, WEEE)



Šis ženklas rodo, kad Europos Sąjungoje šio gaminio negalima išmesti kartu su buitiniems atliekoms. Nebenaudojamą gaminį reikia atiduoti į tam skirtą punktą atnaujinti arba perdirbti. Informacijos apie tinkamą šio gaminio perdirbimą jūsų šalyje rasite interneto svetainėje: www.euro.dell.com/recycling.

Direktiva dwar Skart magħmul minn Tagħmir Elektriku u Elettriku (Waste Electrical and Electronic Equipment - WEEE)



Fl-Unjoni Ewropea, din it-tikketta tindika li dan il-prodott m'għandux jintrema ma' liskart domestiku. Għandu jintrema f'faklità adattata fejn ikun jista' jiġi rkuprat u rikkat. Għal aktar tagħrif dwar kif għandek tirriska dan il-prodott fil-pajjiż tiegħek, jekk jogħġbok zur: www.euro.dell.com/recycling.

Residuos de Aparatos Eléctricos y Electrónicos (RAEE)



En la Unión Europea, esta etiqueta indica que la eliminación de este producto no se puede hacer junto con el deshecho doméstico. Se debe depositar en una instalación apropiada que facilite la recuperación y el reciclado. Para obtener más información sobre cómo reciclar este producto en su país, visite el sitio web: www.euro.dell.com/recycling.

Direktivet for kassert elektrisk og elektronisk utstyr (WEEE)



I den Europeiske Unionen angir dette merket at produktet ikke skal kastes sammen med husholdningsaffald. Det skal leveres til et nettsted for spesialavfall for gjenvinning og resirkulering. For informasjon om hvordan du resirkulerer dette produktet i ditt land, vennligst besøk: www.euro.dell.com/recycling.

Dyrektywa dotycząca odpadów urządzeń elektrycznych i elektronicznych (WEEE)



W Unii Europejskiej etykieta ta oznacza, że tego produktu nie należy wyrzucać razem z odpadami z gospodarstwa domowego. Należy go przekazać do odpowiedniego zakładu, gdzie zostanie poddany odzyskowi i recyklingowi. Informacje o sposobie recyklingu tego produktu w poszczególnych krajach można znaleźć pod adresem: www.euro.dell.com/recycling.

Direktiva WEEE (Waste Electrical and Electronic Equipment)



Na União Europeia, esta etiqueta indica que esse produto não deve ser eliminado juntamente com o lixo normal. Deve ser depositado numa instalação apropriada para recolha e reciclagem. Para obter informações sobre como reciclar este produto de forma responsável no seu país, visite: www.euro.dell.com/recycling.

Direktiva privind deșeurile provenite din echipamentele electrice și electronice (WEEE)



În Uniunea Europeană, această etichetă indică faptul că acest produs nu trebuie aruncat lașeurile cu gunoierii menajeri. El trebuie depozitat într-un loc special amenajat pentru a permite recuperarea și reciclarea. Pentru informații privitoare la reciclarea în mod responsabil a acestui produs în țara dvs., vizitați: www.euro.dell.com/recycling.

Директива об утилизации электрического и электронного оборудования (WEEE)



В Европейском союзе эта маркировка означает, что данный продукт не следует утилизировать вместе с бытовым мусором. Продукт следует утилизировать на специализированном предприятии, чтобы в дальнейшем его можно было переработать. Информацию о правилах утилизации изделия в вашей стране можно получить на веб-узле: www.euro.dell.com/recycling.

Smernica o odpadoch z elektrických a elektronických zariadení (WEEE)



V Európskej únii tento štítek znamená, že sa výrobok nesmie likvidovať ako komunálny odpad. Musí sa odovzdať na príslušnom mieste na obnovu alebo recykláciu. Informácie o správnej recyklácii tohto produktu vo vašej krajine nájdete na stránke: www.euro.dell.com/recycling.

Direktiva o odlaganju električne in elektronske opreme (WEEE)



V Evropski uniji ta znak označuje, da izdelek ni primeren za odlaganje skupaj z običajnimi gospodinjstvi odpadki. Odložiti ga je treba na ustreznem mestu za odlaganje in reciklazo. Za informacije o reciklazi tega izdelka v vaši državi obiščite: www.euro.dell.com/recycling.

Direktiv för kassering av elektrisk och elektronisk utrustning (WEEE - Waste Electrical and Electronic Equipment)



Inom EU betyder den här etiketten att produkten inte får slängas i hushållsaffallet. Den ska lämnas in på en återvinningsstation. Information om hur produkten återvinns i ditt land finns på adressen www.euro.dell.com/recycling.

Waste Electrical and Electronic Equipment (WEEE) Yönergeleri



Avrupa Birliği'nde bu etiket, ürünün ev elektroniği aletleri atıkları ile imha edilemeyeceğini gösterir. Kurtarmak ve geri dönüşümünü sağlamak için uygun şartlarda saklanması gerekir. Bu ürünün geri dönüşümünün nasıl sağlanacağı konusunda bilgi için lütfen şu adresi ziyaret edin: www.euro.dell.com/recycling.
EEE Yönetmeliğine Uygundur Ve Elektronik Eşyalarda Bazı Zararlı Maddelerin Kullanımının Sınırlanmasında Dair Yönetmelik.

Safety, Environmental, and Regulatory Information

FCC Compliance Statement

This MCC has been tested and found to comply with the limits for a Class A digital device, pursuant to Part 15 of the FCC rules. These limits are designed to provide reasonable protection against harmful interference when the equipment is operated in a commercial environment. This equipment generates, uses, and can radiate radio frequency energy and, if not installed and used according to the instructions, may cause harmful interference to radio communications. Operation of this equipment in a residential area is likely to cause harmful interference in which case the user will be required to correct the interference at their own expense.

Operation of this equipment is subject to the following two conditions: (1) this device may not cause harmful interference, and (2) this device must accept any interference received, including interference that may cause undesired operation.

FCC Caution: Changes or Modifications not expressly approved by Ergotron could void the user's authority to operate the equipment.

This Class A digital apparatus complies with Canadian CAN ICES-3(A)/NMB-3(A). / Cet appareil numérique de la classe A est conforme à la norme CAN ICES-3(A)/NMB-3(A) du Canada.

Registration, Evaluation, Authorization of Chemicals (REACH)

REACH is the European Union (EU) chemical substances regulatory framework. Information on substances of very high concern contained in Dell products in a concentration above 0.1% weight by weight (w/w) can be found at www.dell.com/REACH

Enregistrement, évaluation, autorisation des produits chimiques (REACH)

REACH est le programme de réglementation des produits chimiques dans l'Union européenne (UE). Vous trouverez des informations sur les substances très préoccupantes qui contiennent les produits Dell en concentration supérieure à 0,1% en poids (m/m) sur www.dell.com/REACH

Registro, evaluación y autorización de productos químicos (Registration, Evaluation, Authorization of Chemicals - REACH)

REACH es el organismo de regulación de sustancias químicas de la Unión Europea (UE). La información sobre sustancias de alto riesgo contenidas en productos Dell en una concentración superior al 0,1% peso por peso (p/p) se puede encontrar en www.dell.com/REACH

Registration, Evaluation, Authorization of Chemicals (REACH)

REACH is het regelgevingskader van de Europese Unie (EU) op het gebied van chemische stoffen. Informatie over zeer gevaarlijke stoffen in Dell-producten in een concentratie van boven de 0,1% gewicht per gewicht (w/w) is te vinden op www.dell.com/REACH

REACH (Registration, Evaluation, Authorization of Chemicals - Registo, avaliação e autorização de substâncias químicas)

O REACH é o sistema regulador de substâncias químicas da União Europeia (UE). As informações sobre substâncias que são motivo de grande preocupação existentes nos produtos Dell numa concentração acima de 0,1% peso por peso (p/p) podem ser encontradas em www.dell.com/REACH

Registrierung, Beurteilung und Zulassung von Chemikalien (REACH, Registration, Evaluation, Authorization of Chemicals)

Die EU-Richtlinie REACH ist das Regelwerk der Europäischen Union für chemische Substanzen. Informationen zu bedenklichen Substanzen, die in Dell-Produkten in einer Konzentration von mehr als 01 Gewichtsprozent (w/w, Weight by Weight) enthalten sind, finden Sie unter www.dell.com/REACH

中国大陆 RoHS

根据中国大陆《电子信息产品污染控制管理办法》（也称为中国大陆 RoHS），以下部分列出了产品中可能包含的有毒和/或有害物质的名称和含量。

DELL I/O设备（键盘，鼠标等）

EIP（RMSD，介质，电源设备及所有其他电子信息产品）

部件名称	有毒或有害物质及元素					
	铅 (Pb)	汞 (Hg)	镉 (Cd)	六价铬 (Cr VI)	多溴联苯 (PBB)	多溴联苯醚 (PBDE)
EIP	x	o	o	o	o	o
介质/软件	x	o	o	o	o	o



*印刷电路部件包括所有印刷电路板 (PCB) 及其各自的离散组件、IC 及连接器。

“O”表明该部件所含有的有毒和有害物质含量低于 MCV 标准 (SJ/T11363-2006) 定义的阈值。

“X”表明该部件所含有的有毒和有害物质含量高于 MCV 标准 (SJ/T11363-2006) 定义的阈值。所有显示 X 的情况，是按照欧盟 RoHS 采用了容许的豁免指标。

在中国大陆销售的相应电子信息产品 (EIP) 都必须遵照中国大陆《电子信息产品污染控制标识要求》标准 (SJ/T11363-2006) 贴上环保使用期限 (EPUP) 标签。该产品所采用的 EPUP 标签是基于中国大陆的《电子信息产品环保使用期限通则》标准。



Warranty

3 years for mechanical components and functions and 1 year for electrical components and functions. All third-party components (AC Power Adapter and optional Ethernet Switch) will follow the warranty as defined by the manufacturer.

CUSTOM SOLUTION FOR DELL BY ERGOTRON
For service, visit www.ergotron.com/Dell
or www.dell.com/support



© 2013 Ergotron, Inc.
All rights reserved.

While Ergotron, Inc. makes every effort to provide accurate and complete information on the installation and use of its products, it will not be held liable for any editorial errors or omissions (including those made in the process of translation from English to another language), or for incidental, special or consequential damages of any nature resulting from furnishing this instruction and performance of equipment in connection with this instruction. Ergotron, Inc. reserves the right to make changes in the product design and/or product documentation without notification to its users. For the most current product information, or to know if this document is available in languages other than those herein, please contact Ergotron. No part of this publication may be reproduced, stored in a retrieval system, or transmitted in any form or by any means, electronic, mechanical, photocopying, recording or otherwise without the prior written consent of Ergotron, Inc., 1181 Trapp Road, Eagan, Minnesota, 55121, USA Patents Pending and Patented U.S. & Foreign. Ergotron is a registered trademark of Ergotron, Inc.